

PUMP RANGE

TERMOMECCANICA POMPE

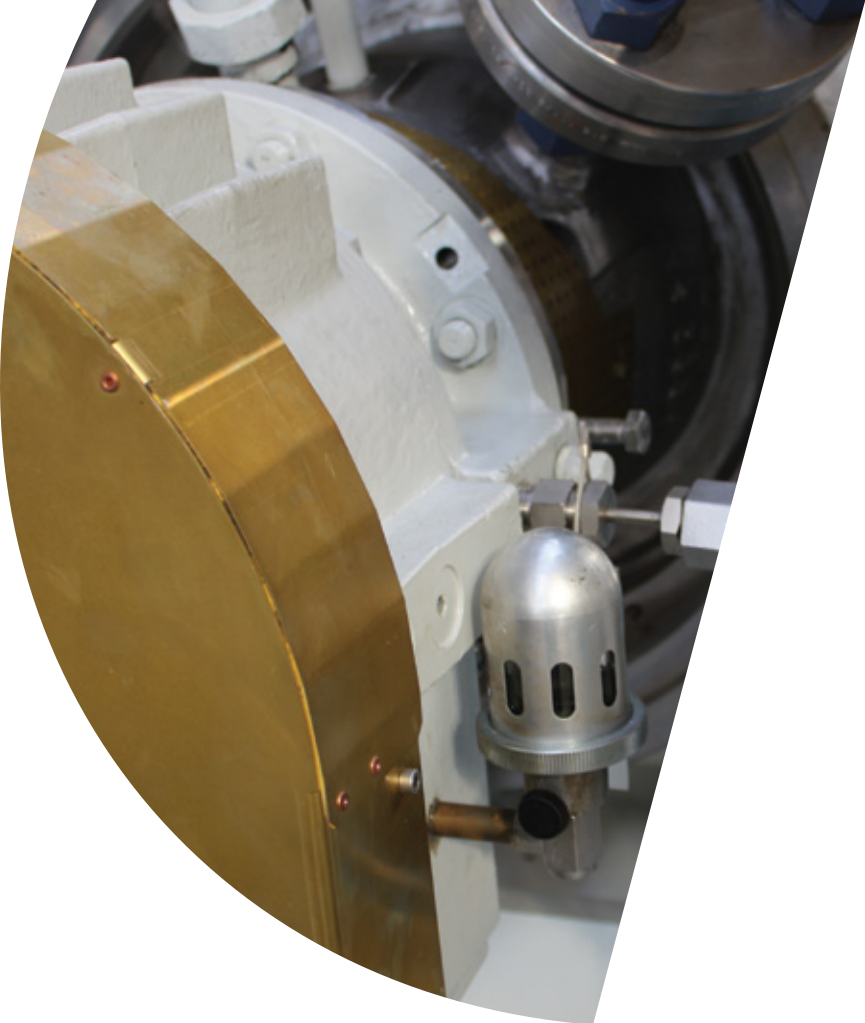

TERMOMECCANICA POMPE

A UNIQUE PUMP PARTNER FOR YOUR PLANT PROJECTS

With its 110 years of experience, Termomeccanica Pompe, who recently joined the Trillium Flow Technologies group, is a unique technological partner offering highly integrated engineered pumps solutions tailored to its customers specific project needs, especially in terms of efficiency and reliability.

Termomeccanica Pompe's engineered pumps solutions are not limited to original equipment design and manufacturing but also cover the provision of an extensive portfolio of after-sales service activities for the Oil & Gas, Water, Desalination, Power Generation, and other industrial sectors.

OIL & GAS

Termomeccanica Pompe offers a wide range of API 610 engineered pumps in compliance with the most stringent technical specifications of the Upstream, Midstream and Downstream sectors. The company's pump range covers the most demanding services of the industry such as those related to onshore & offshore water injection plants, oil pipelines, LNG terminals, refineries & petrochemical plants.

WATER

The history of Termomeccanica Pompe is closely linked to the handling & transmission of medium & large masses of water. With its product range, the company covers all main and auxiliary services in Potable Water, Irrigation, Land Reclamation, Water Treatment as well as other industrial plants.

DESALINATION

Termomeccanica Pompe's product offering covers all process and water intake services related to the various desalination technologies: latest-generation SWRO, MSF, and MED.

POWER GENERATION

Termomeccanica Pompe provides pumps for all types of power plants - i.e. conventional steam, combined cycle, geothermal and nuclear - covering all main and auxiliary services such as boiler feed water, condensate extraction, circulating cooling and close circuit cooling.



YOUR PUMP PARTNER, YESTEDAY, TODAY AND TOMORROW



INDEX

PUMP MATRIX

Overview of Termomeccanica Pompe products per market and application P.07

PRODUCT RANGE

Horizontal single-stage overhung pumps
API-610 type: OH2 • TMP model: AP P.09

Horizontal between-bearings, axially split, one-stage, double-suction pumps
API-610 type: BB1 • TMP model: DD P.11

Horizontal between-bearings, axially split, one-stage, double-suction pumps
API-610 type: N.A. • TMP patented model: HSS P.12

Horizontal between-bearings, axially split, two-stage pumps
API-610 type: BB1 • TMP model: D2 – D2D – DD2D P.15

Horizontal between-bearings, radially split, one-stage, double-suction pumps
API-610 type: BB2 • TMP model: DP P.17

Horizontal between-bearings, radially split, two-stage pumps
API-610 type: BB2 • TMP model: A2P – A2PD P.19

Horizontal between-bearings, axially split, multi-stage pumps
API-610 type: BB3 • TMP model: PF P.21

Horizontal between bearings, single-casing, radially split, multi-stage pumps
API-610 type: BB4 • TMP model: MES - MESD P.23

Horizontal between bearings, double casing, radially split, multi-stage pumps
API-610 type: BB5 • TMP model: MESB – MESBD P.25

Vertically suspended, wet pit, single casing, single or multistage, diffuser or volute pumps
API-610 type: VS1-VS2 • TMP model: CPP - CPPD P.27

Vertically suspended, wet pit, single-casing, axial-flow pumps
API-610 type: VS3 • TMP model: EV P.29

Vertically suspended, single-casing, volute, line-shaft driven sump pumps
API-610 type: VS4 • TMP model: CPPL P.31

Vertically suspended, canned, single- or double-suction, single- or multi-stage pumps
API-610 type: VS6 – VS7 • TMP model: CEX – CEXD P.33

Large vertical volute dry pit pumps
API-610 type: N.A. • TMP model: NV P.35



TERMOMECCANICA POMPE

PUMP MATRIX FOR OIL & GAS SERVICES

PUMP TYPE	OVERHUNG	1-2 STAGE BETWEEN BEARINGS						MULTISTAGE BETWEEN BEARINGS			VERTICALLY SUSPENDED				
		AXIALLY SPLIT				RADIALLY SPLIT		AXIALLY SPLIT	SINGLE CASE	DOUBLE CASE	SINGLE CASE			DOUBLE CASE	
		DD	HSS	D2-D 2D-DD2D	DP	A2P	A2PD		RADIALLY SPLIT	DIFFUSER	VOLUTE	VOLUTE	DIFFUSER	VOLUTE	
API 610 - TYPE CODE	OH2	BB1			BB2			BB3	BB4	BB5	VS1	VS2	VS4	VS6	VS7
TMP MODEL CODE	AP	DD	HSS	D2-D 2D-DD2D	DP	A2P	A2PD	PF	MES	MESB	CPP	CPPD	CPPL	CEX	CEXD
UPSTREAM															
Sea water lifting											●	●			
Oil well water injection	●	●			●	●	●	●	●	●				●	●
Oil well water injection booster		●													
Shipping service														●	●
Oil Transfer		●			●									●	●
FPSO -FSO -FPO	●	●			●			●		●					
Heavy oil ,oil sands and shale	●	●			●	●	●			●			●		
Auxiliary services	●										●		●		
MIDSTREAM															
Hydrocarbon pipelines		●		●	●	●	●	●		●				●	●
Sea Water/ Spray services											●	●			
Charge / Discharge services	●	●													
DOWNSTREAM															
Distillation	●	●			●	●	●							●	
Hydrotreating	●				●	●	●			●				●	
Hydrocracking	●				●	●	●			●				●	
Catalytic cracking	●				●	●	●			●				●	
Residuum & heavy oil upgrading	●				●	●	●			●				●	
Gas treating & sulphur recovery	●	●			●	●	●			●				●	●
LNG, NGL, LPG	●	●		●	●	●	●			●	●	●	●	●	●
Gas Reliquefaction	●	●			●	●	●			●			●		

PUMP MATRIX FOR POWER GENERATION, WATER & OTHER INDUSTRIAL SERVICES

PUMP TYPE	OVERHUNG	1-2 STAGE BETWEEN BEARINGS						MULTISTAGE BETWEEN BEARINGS			VERTICALLY SUSPENDED						SPECIAL DESIGN
		AXIALLY SPLIT				RADIALLY SPLIT		AXIALLY SPLIT	SINGLE CASE		SINGLE CASE			DOUBLE CASE			
		DD	HSS	D2-D 2D-DD2D	DP	A2P	A2PD		RADIALLY SPLIT	DIFFUSER	VOLUTE	AXIAL FLOW	VOLUTE	DIFFUSER	VOLUTE		
API 610 - TYPE CODE	OH2	BB1			BB2			BB3	BB4	BB5	VS1	VS2	VS3	VS4	VS6	VS7	N.A.
TMP MODEL CODE	AP	DD	HSS	D2-D 2D-DD2D	DP	A2P	A2PD	PF	MES	MESB	CPP	CPPD	EV	CPPL	CEX	CEXD	NV
POWER GENERATION																	
Main boiler feed water					●			●	●	●							
Startup & emergency feed water								●	●	●							
Booster	●	●			●												
Condensate extraction	●	●													●	●	●
Condenser cooling water		●									●	●					
Closed cooling water system	●	●	●								●	●					
Auxiliary services	●	●	●								●						
Geothermal services	●	●													●	●	
Nuclear auxiliary services	●	●			●			●	●	●	●	●			●	●	
WATER																	
Sea water desalination	●	●	●					●	●		●	●			●	●	●
Water transportation		●		●				●	●	●	●	●					●
Water distribution	●	●	●						●		●	●					
Flood control		●									●	●	●				
Irrigation & land reclamation		●									●	●	●				●
Water treatment	●	●									●		●	●			
INDUSTRY																	
Cooling water	●	●	●						●		●						●
Water supply & storage		●									●	●					●
Boiler feed	●				●	●	●	●	●	●	●						
Fire fighting	●	●						●	●	●	●	●					
Descaling								●	●	●							
Auxiliary services	●	●	●		●						●				●		

API 610 OH2-TYPE PUMPS • TMP AP PUMP MODEL
PHOTO: TMP AP PUMP MODEL FOR AMINE PREPARATION SERVICE AT OIL FIELD FACILITY

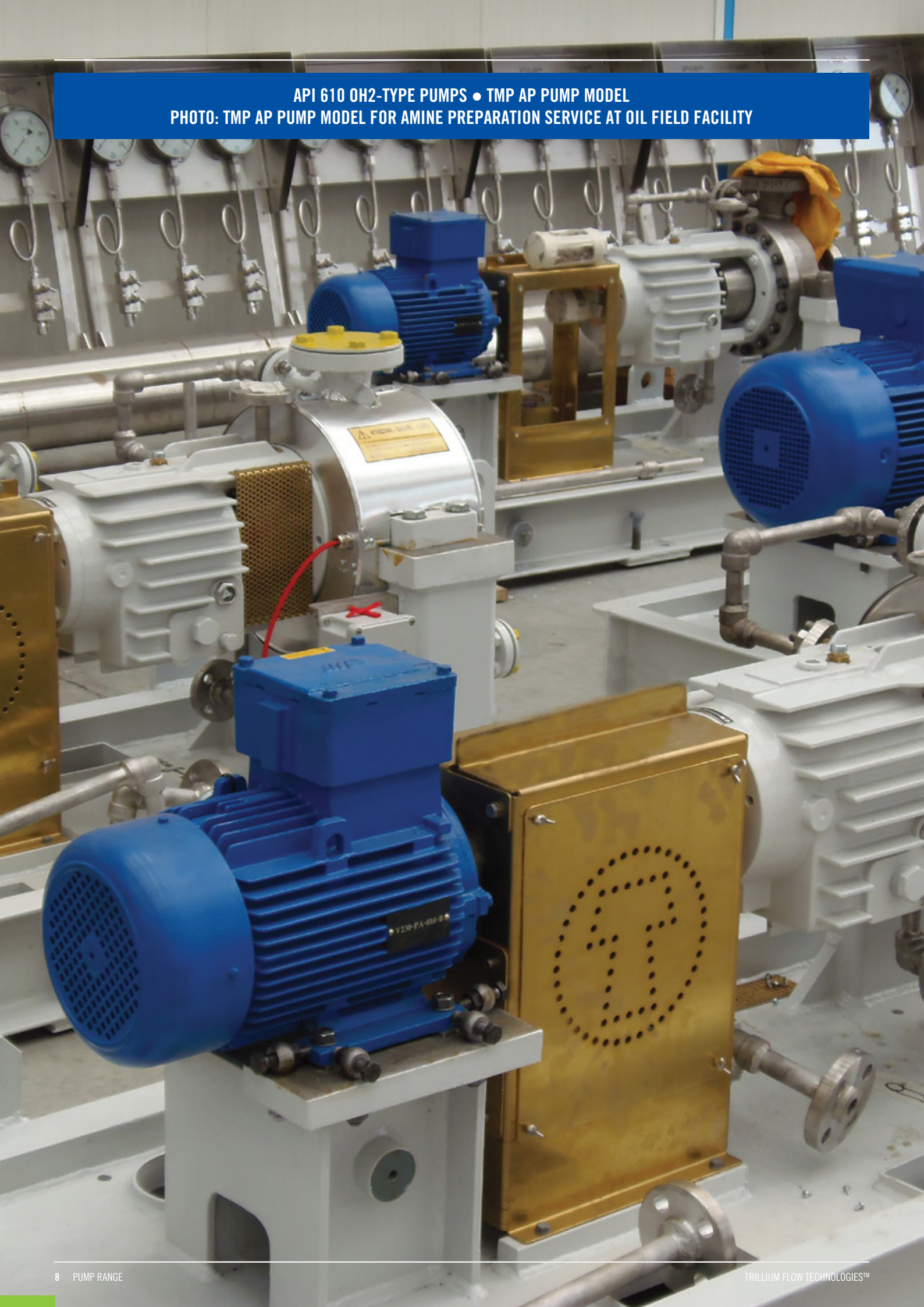

HORIZONTAL SINGLE-STAGE OVERHUNG PUMPS

API-610 TYPE: OH2

TERMOMECCANICA PUMP MODEL: AP

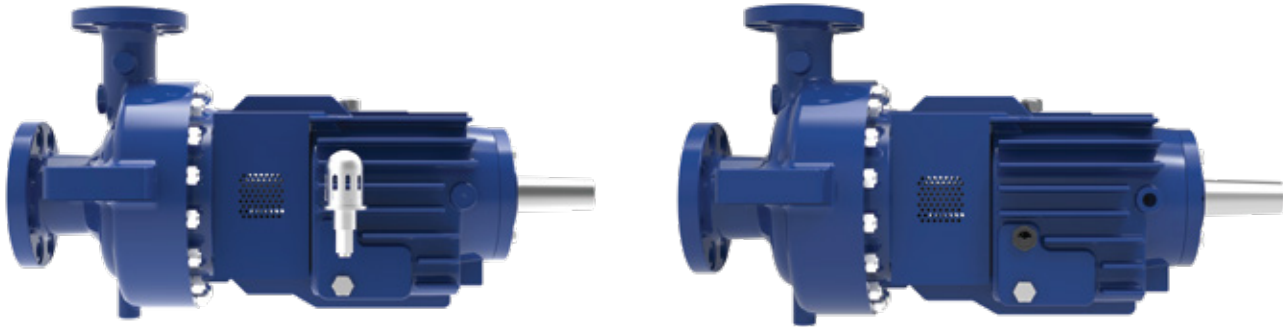

KEY FEATURES:

- Single-stage, single-suction radial impeller, end/top centrifugal pumps
- Thanks to the back pull-out arrangement, maintenance activities are made easier and can be carried out without disconnecting the piping or removing the driver
- Center-line assembly, large diameter shaft and very stiff bearing casing assure proper alignment of the rotating parts during the most critical conditions
- Seal chamber according to API 682 for any mechanical seal configuration and API 610 seal flushing plan
- Coke crusher can be provided upon request

MAIN APPLICATIONS:

- Heavy duty services in Oil & Gas processing
- Boiler circulation & other high temperature industrial services
- Water market & general auxiliary pumping systems

OPERATING RANGE

- Capacity: up to 4,000 m³/h 17,611 gpm
- Head: up to 400 m 1,300 ft.
- Pressure: up to 100 bar 1,450 psig
- Temperature: range -100 to +450 °C -150 to +840 °F

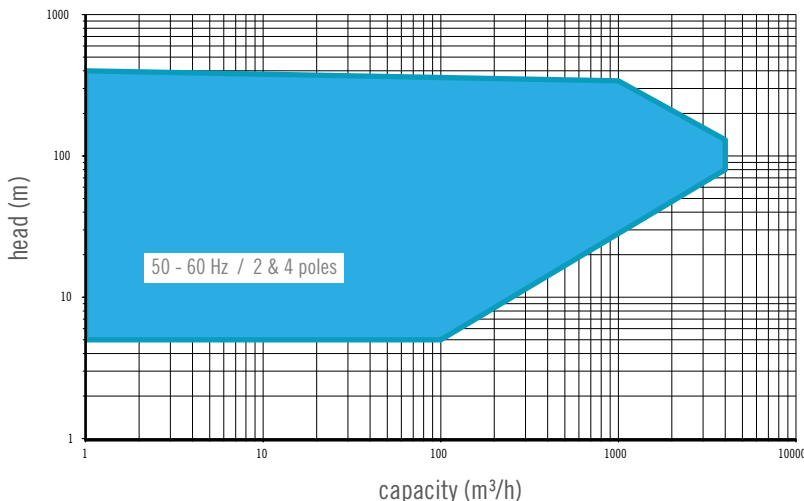

API-610 BB1-TYPE PUMPS • TMP DD PUMP MODEL
PHOTO: TMP DD PUMP MODEL FOR MAIN OIL LINE SERVICE AT PIPELINE



HORIZONTAL BETWEEN-BEARINGS, AXIALLY SPLIT, ONE-STAGE, DOUBLE-SUCTION PUMPS

API-610 TYPE: BB1

TERMOMECCANICA PUMP MODEL: DD



MAIN APPLICATIONS:

- Water transportation
- Water supply and distribution
- Cooling water services in industrial plants
- Boiler feed boosting & condensate extraction in power plants
- Sea water desalination
- Crude oil pipeline
- Tank farm transfer
- Ship charge and discharge
- General industry

KEY FEATURES:

- Axially split casing, single stage double entry impeller, double volute, between bearings pumps
- Very large number of hydraulics optimized for any need-medium and high capacities, low and high heads
- Near centerline foot mounted for high temperature (DDH)
- Vertical arrangement available (DDBV)
- Bearing type and lubrication
 - Antifriction radial and thrust bearings, oil bath or oil ring lubricated
 - Hydrodynamic radial and rolling element thrust bearings, lubricated by oil bath or oil ring
 - Hydrodynamic radial and thrust bearings with pressurized oil system, for higher speed and power

OPERATING RANGE

- Capacity: up to 30,000 m³/h 132,000 gpm
- Head: up to 600 m 1,970 ft.
- Pressure: up to 150 bar 2,180 psig
- Temperature: up to 200°C 392 °F
- Speed of rotation up to 5,000 rpm 5,000 rpm

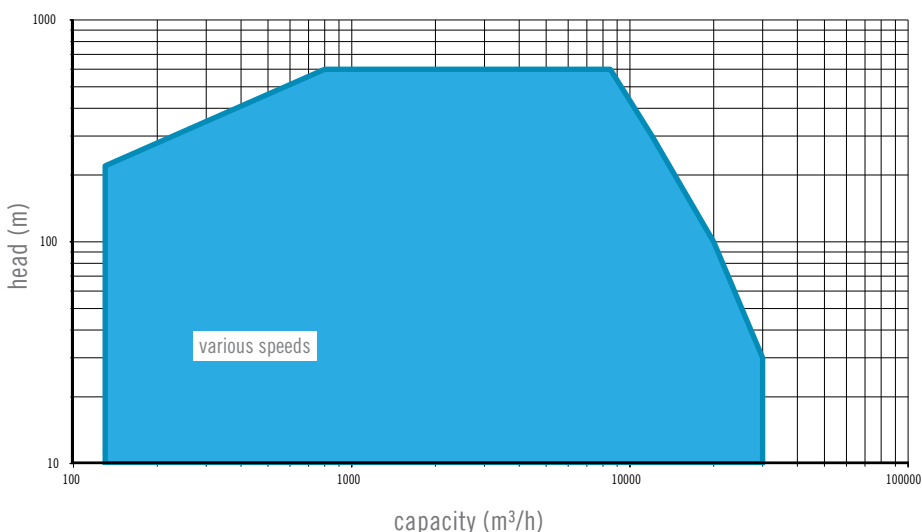

HORIZONTAL BETWEEN-BEARINGS, AXIALLY SPLIT, ONE-STAGE, DOUBLE SUCTION PUMPS • TMP HSS PUMP MODEL
PHOTO: TMP HSS PUMP MODEL FOR MUNICIPAL WATER SYSTEMS

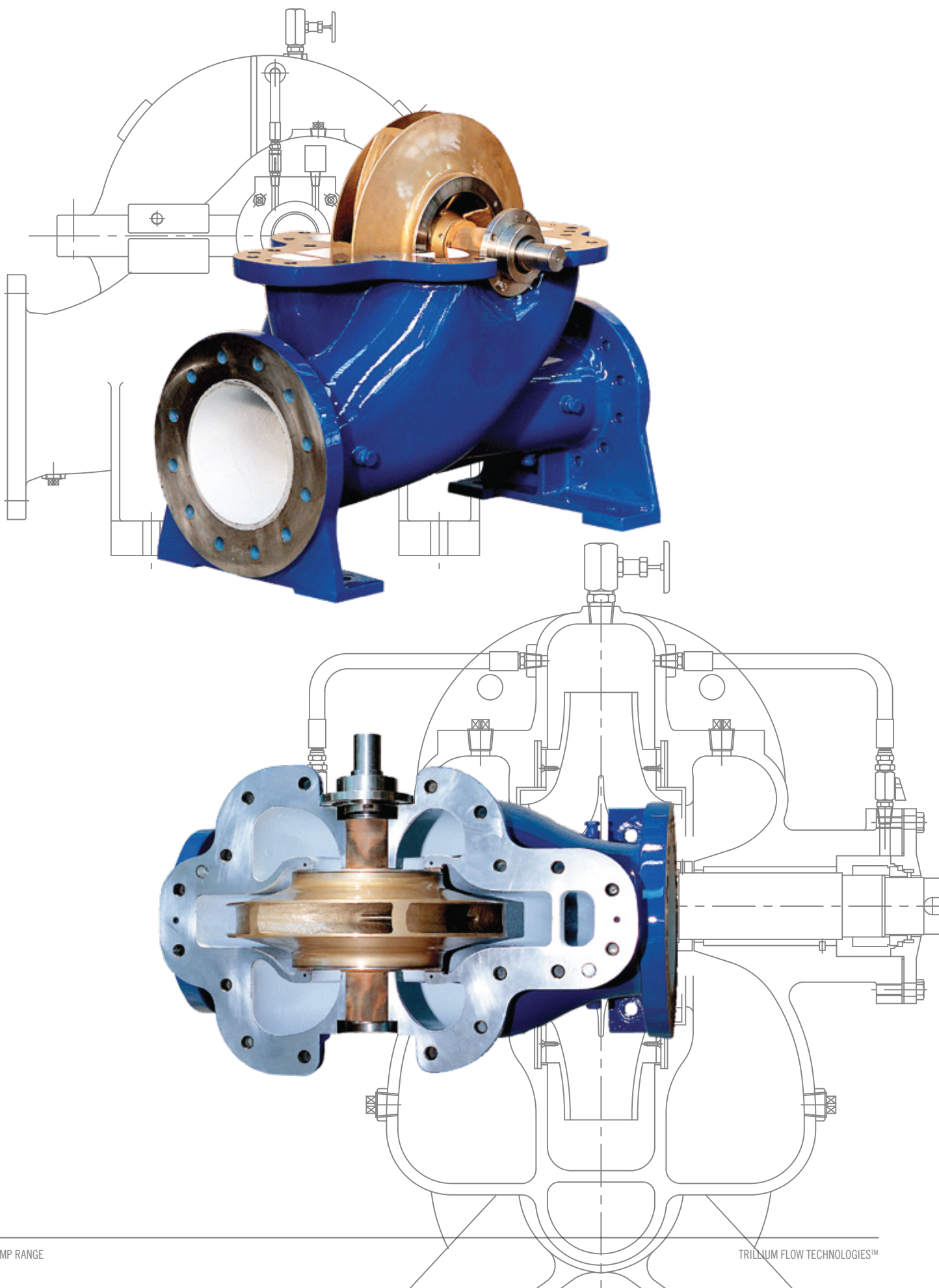

HORIZONTAL BETWEEN-BEARINGS, AXIALLY SPLIT, ONE-STAGE, DOUBLE SUCTION PUMPS

API-610 TYPE: BB1 - N/A

TERMOMECCANICA PUMP MODEL: HSS (PATENTED DESIGN)

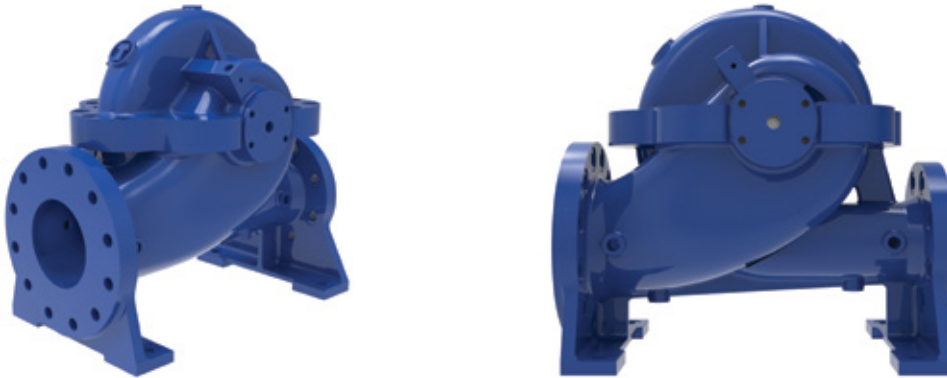

KEY FEATURES:

- Horizontal between-bearings, axially split, single stage, double suction pumps like our DD pumps but with a patented design where standard bearing housings are removed
- Axial hydraulic thrusts are compensated by disc-type wear rings
- Only one seal (either mechanical or packing) is provided on drive end side
- The pump's reduced number of components and simplicity of assembly/disassembly reduce operating & maintenance costs while maintaining a high level of efficiency, safety & reliability

MAIN APPLICATIONS:

- Water transmission, distribution and irrigation
- Various services in Reverse Osmosis Desalination plants
- Clean or slightly polluted water and hydrocarbon services in general industry

OPERATING RANGE

- Capacity: up to 4,000 m³/h 18,000 gpm
- Head: up to 200 m 650 ft.
- Pressure: up to 25 bar 360 psig
- Temperature: up to + 150 °C 300 °F

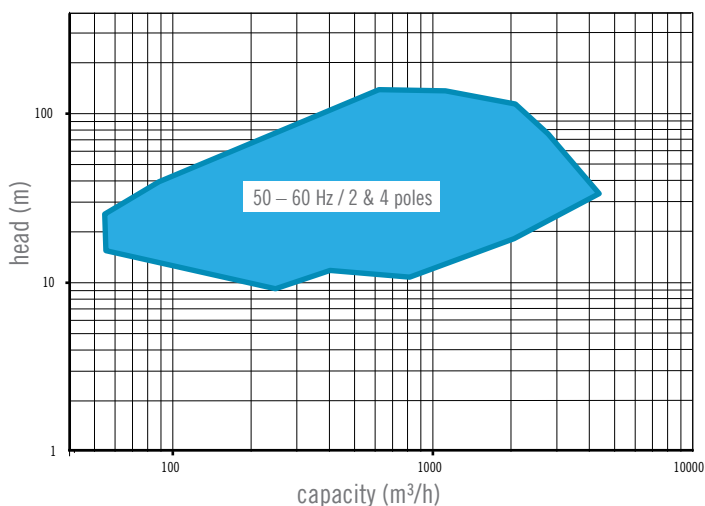

API-610 BB1-TYPE PUMPS • TMP D2 - D2D - DD2D PUMP MODELS
TMP D2D PUMP MODEL FOR MAIN LINE SERVICE AT WATER TRANSMISSION PLANT



HORIZONTAL BETWEEN-BEARINGS, AXIALLY SPLIT, ONE-STAGE, DOUBLE SUCTION PUMPS

API-610 TYPE: BB1

TERMOMECCANICA PUMP MODEL: D2 - D2D - DD2D

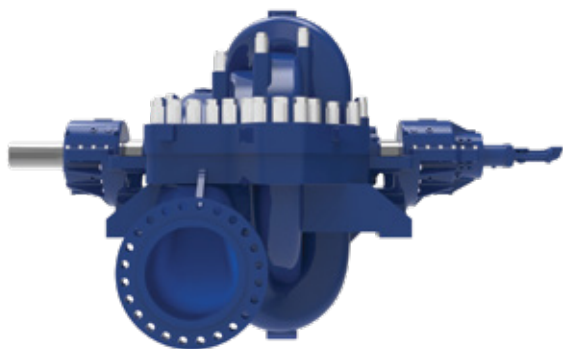

MAIN APPLICATIONS:

- Water transportation
- High pressure services in sea water desalination plants
- Crude oil pipelines
- Applications requiring high capacities and high head services

KEY FEATURES:

- Axially split casing, double volute, two stage, between bearings pumps:
 - D2 has two single suction impellers and a back-to-back arrangement
 - D2D has two double suction impellers and volute is staggered to reduce pressure pulsations
 - DD2D has first stage double entry impeller, second stage single entry impeller. To minimize axial hydraulic forces, a solution with first stage consisting of two single entry, back-to-back impellers, with diffuser design is also available
- Bearings and lubrication:
 - Anti friction radial and thrust bearings, oil bath or oil ring lubricated
 - Hydrodynamic radial and rolling element thrust bearings, lubricated by oil bath or oil ring
 - Hydrodynamic radial and thrust bearings with pressurized oil system, for higher speed and power
- Near centerline mounted casing
- Hydraulics optimized through extensive CFD analyses & experimental tests

OPERATING RANGE

- | | | | |
|---------------------|-------|--------------------------|------------|
| • Capacity: | up to | 20,000 m ³ /h | 88,057 gpm |
| • Head: | up to | 800 m | 2,625 ft. |
| • Pressure: | up to | 150 bar | 2,180 psig |
| • Temperature: | upto | +150 °C | 302 °F |
| • Speed of rotation | up to | 5,000 rpm | 5,000 rpm |

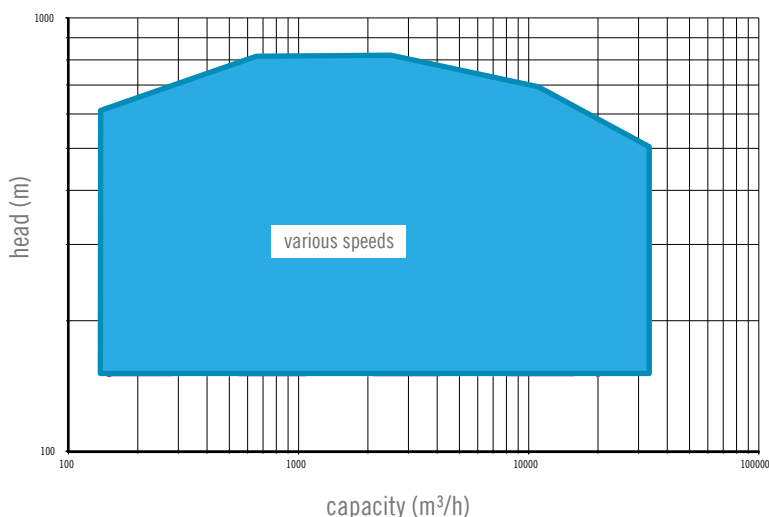

API-610 BB2-TYPE PUMPS • TMP DP PUMP MODEL
PHOTO: TMP DP PUMP MODEL FOR REACTOR FEED SERVICE AT REFINERY

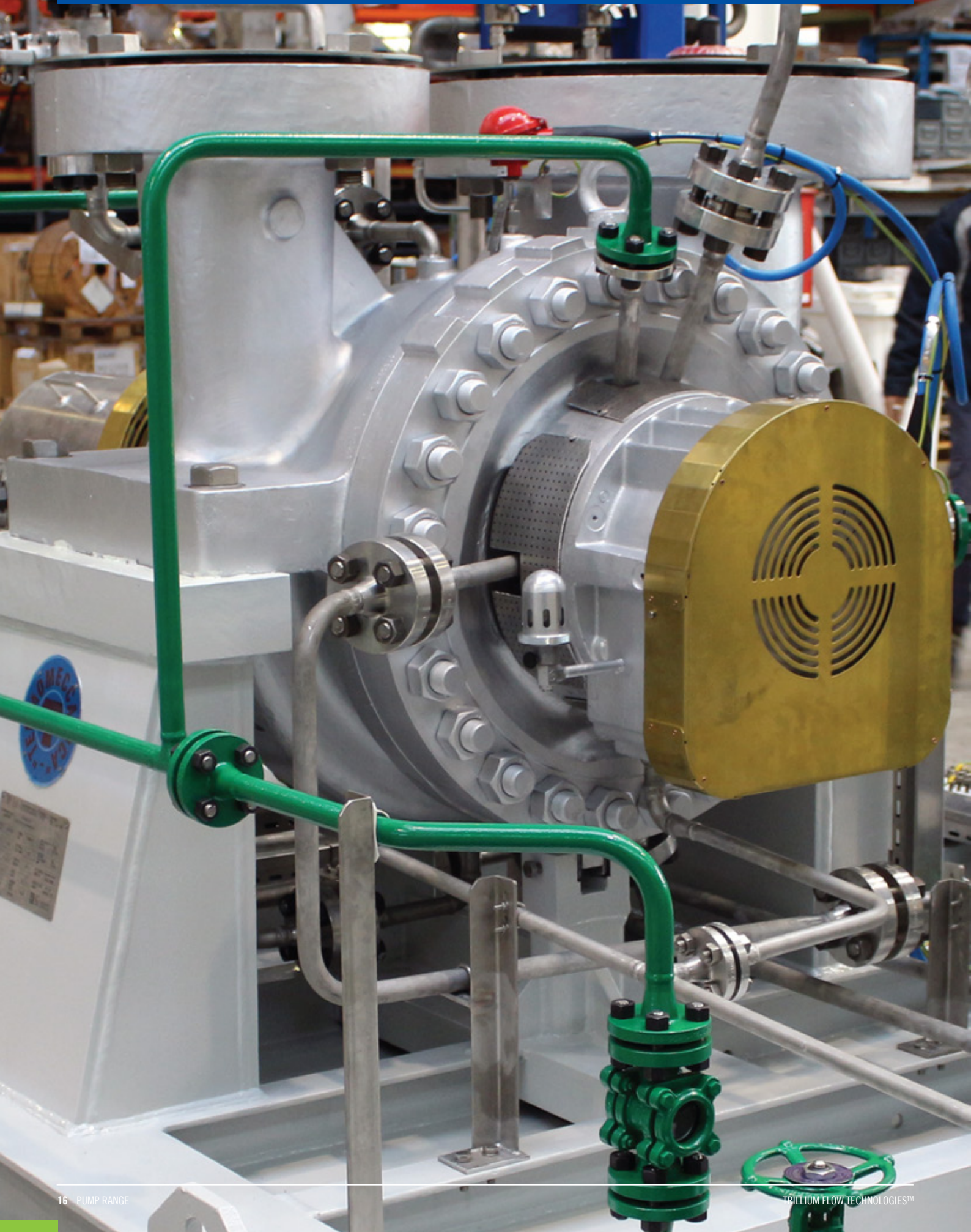

HORIZONTAL BETWEEN-BEARINGS, RADIALY SPLIT, ONE-STAGE, DOUBLE-SUCTION PUMPS

API-610 TYPE: BB2

TERMOMECCANICA PUMP MODEL: DP



MAIN APPLICATIONS:

- Refinery and petrochemical services
- Oil well water injection
- Oil transfer
- FPSO - FSO - FPO
- Hydrocarbon pipelines
- Boiler feed and booster in fossil fuel and nuclear power stations
- Auxiliary services in nuclear power plant and general industry

KEY FEATURES:

- Radially split, single stage double entry impeller, double volute, between bearings pumps
- Heavy duty process pumps, centerline-mounted for high temperature, high pressure services
- Centerline arrangement helps avoiding misalignment at elevated temperatures. Additional features are provided to compensate axial thermal expansion
- Nozzles are top-top but side-side, bottom-side, and side-top options are available upon request
- Double volute casing to reduce radial hydraulic thrust. Double cover design allows easy access for maintenance
- On the largest sizes, single cover solution is adopted
- For the highest speeds and heads, diffuser design is available together with staggered vane impeller
- Very sturdy pump casing to withstand high nozzle loads
- Bearings: ball/ball, sleeve/ball and sleeve/tilting pads solutions are available
- Coke crusher available upon request

OPERATING RANGE

- | | | | |
|---------------------|-------|-------------------------|------------|
| • Capacity: | up to | 5,000 m ³ /h | 22,014 gpm |
| • Head: | up to | 600 m | 1,970 ft. |
| • Pressure: | up to | 150 bar | 2,180 psig |
| • Temperature: | up to | +450 °C | 842 °F |
| • Speed of rotation | up to | 6,000 rpm | 6,000 rpm |

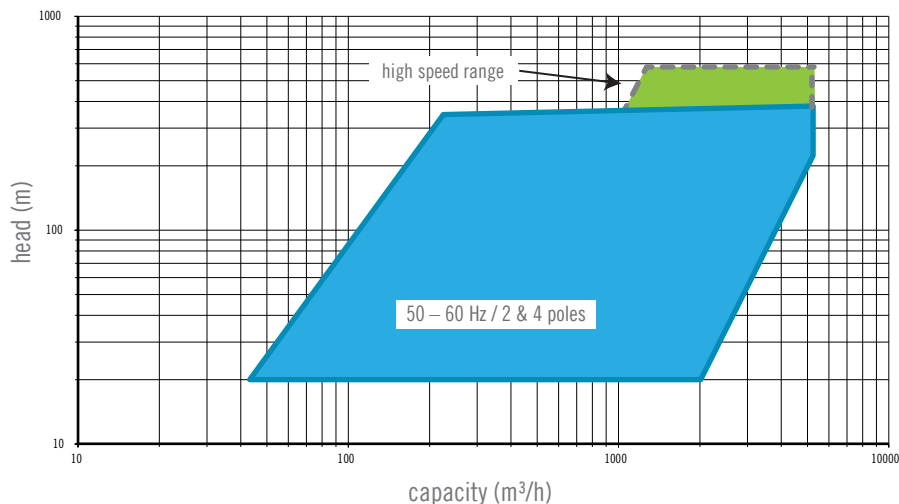

API-610 BB2-TYPE PUMPS • TMP A2P–A2PD PUMP MODELS
PHOTO: TMP A2P PUMP MODEL FOR SPONGE OIL SERVICE AT REFINERY

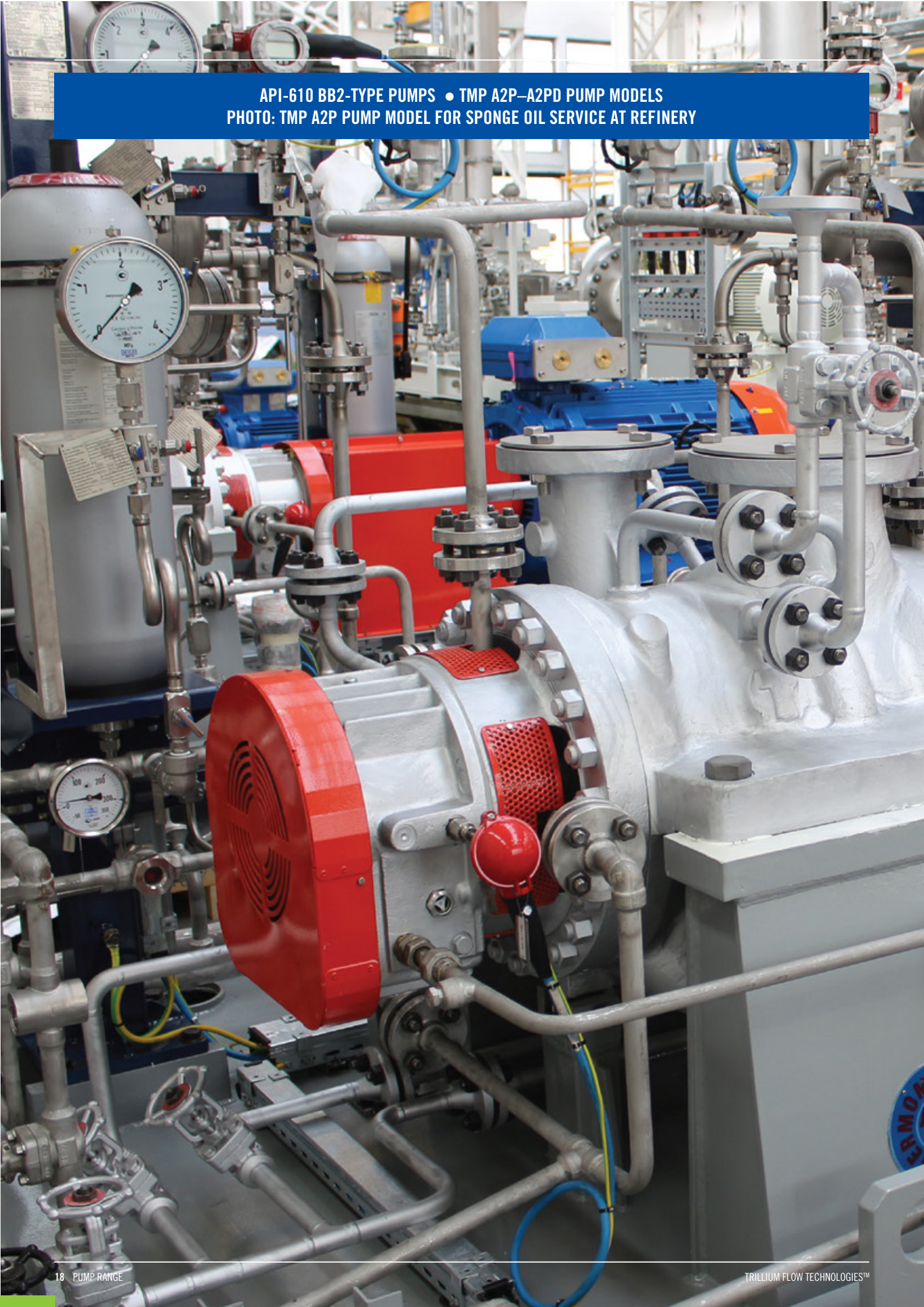

HORIZONTAL BETWEEN-BEARINGS, RADIALY SPLIT, TWO-STAGE PUMPS

API-610 TYPE: BB2

TERMOMECCANICA PUMP MODEL: A2P –A2PD



A2P



A2PD

MAIN APPLICATIONS:

- Refinery and petrochemical services
- Oil well water injection
- Hydrocarbon pipelines
- Liquefied gas industry
- Offshore installation

KEY FEATURES:

- Radially split, single stage double entry impeller, double volute, between bearings pumps, centerline-mounted for heavy duty processes (high temperature, high pressure services)
- Top-top nozzles is standard. Side-top or side-side is optional
- On A2P models, two single entry impellers, with back-to-back arrangement to compensate axial hydraulic loads
- A2PD models have first stage double entry impeller for low NPSH applications
- Opposed volute design to reduce radial hydraulic forces
- Pump casing is very sturdy to withstand high nozzle loads
- Bearings: ball/ball, sleeve/ball and sleeve/tilting pads solutions are available
- Coke crusher available upon request

OPERATING RANGE

- Capacity: up to 2,000 m³/h 8,800 gpm
- Head: up to 750 m 2,460 ft.
- Pressure: up to 150 bar 2,180 psig
- Temperature: up to +450°C 842 °F

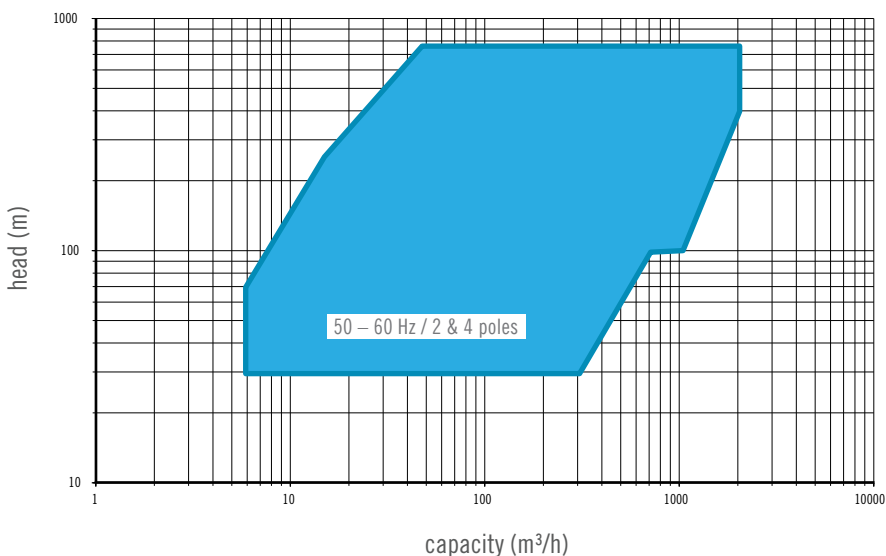

API 610 BB3-TYPE PUMPS • TMP PF PUMP MODEL
PHOTO: TMP PF PUMP MODEL FOR BOILER FEED WATER SERVICE AT OIL FIELD FACILITY

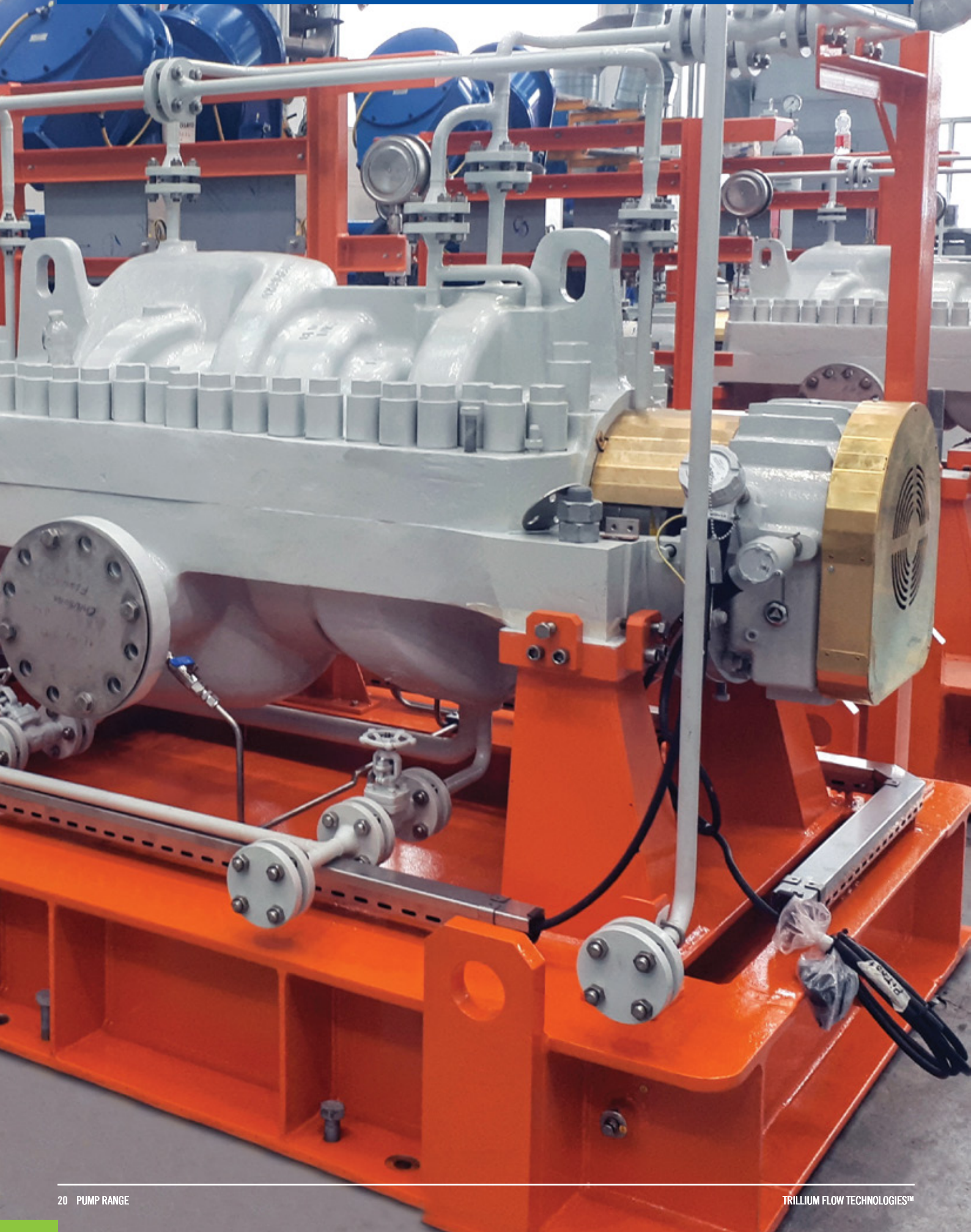

HORIZONTAL BETWEEN-BEARINGS, AXIALLY SPLIT, MULTI-STAGE PUMPS

API-610 TYPE: BB3

TERMOMECCANICA PUMP MODEL: PF

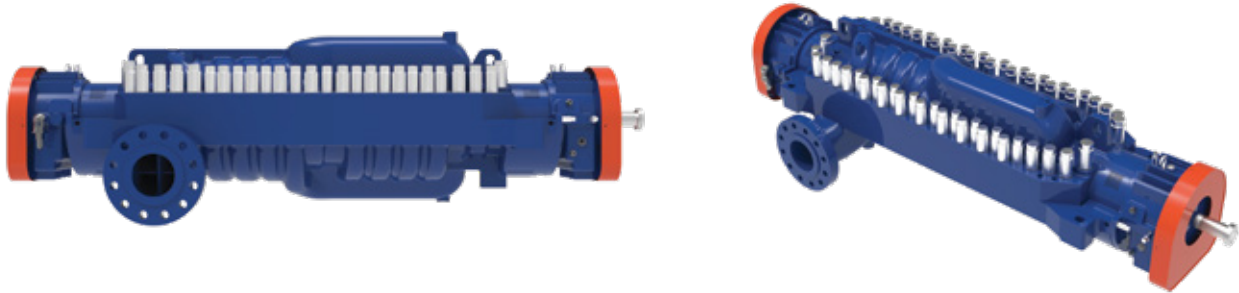

KEY FEATURES:

- Heavy duty, high pressure, double volute casing, multistage opposed impellers, near centerline mounted pumps
- First stage double entry impeller for low NPSH applications
- Opposed impellers arrangement for axial thrust balancing and minimum bearing loads
- Double volute design for radial thrust reduction to minimize the shaft deflection
- Suction and discharge nozzles are integrally cast with the bottom half casing, on opposite sides
- Ball/ball, sleeve/ball and sleeve/tilting pads solutions are available
- De-staging can be provided upon request
- Special features are used to compensate thermal expansion and ensure casing alignment

MAIN APPLICATIONS:

- Oil well water injection
- Hydrocarbon pipelines
- Liquefied gas industry
- Offshore installation
- Water transportation
- Reverse Osmosis HP service
- Boiler feed
- Nuclear auxiliary services
- Fire fighting

OPERATING RANGE

- Capacity: up to 3,000 m³/h 13,210 gpm
- Head: up to 2,500 m 8,200 ft.
- Pressure: up to 300 bar 4,350 psig
- Temperature: up to + 200 °C 392 °F
- rotational speed up to 6,000 rpm 6,000 rpm

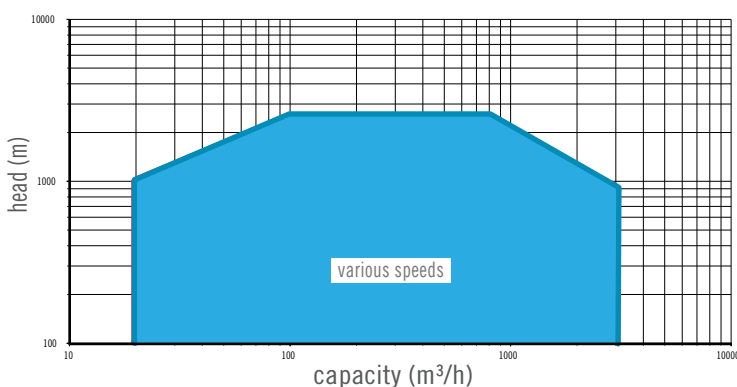

API 610 BB4-TYPE PUMPS • TMP MES-MESD PUMP MODELS
PHOTO: TMP MES PUMP MODEL FOR BOILER FEED WATER SERVICE AT POWER PLANT

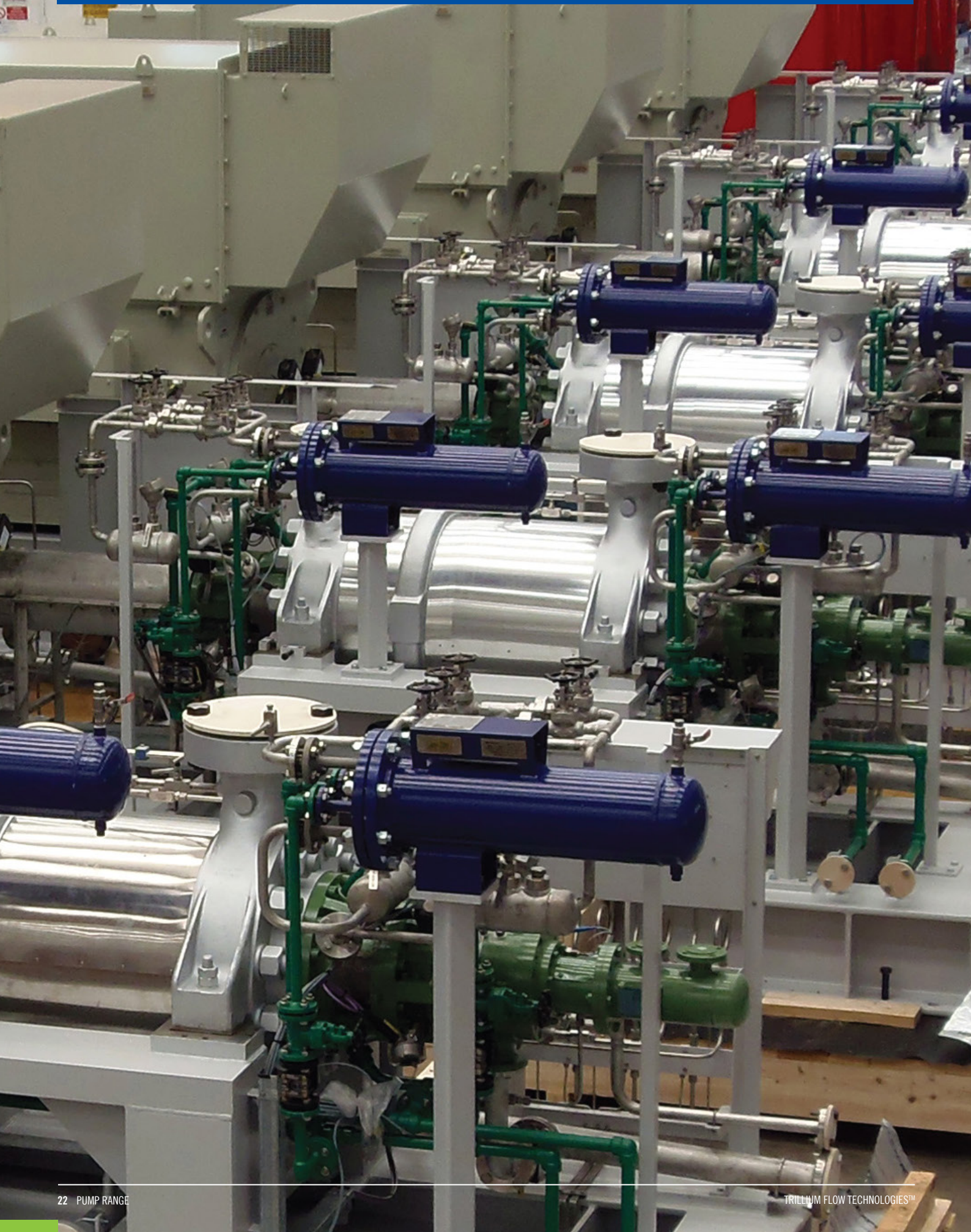

HORIZONTAL HIGH PRESSURE MULTI-STAGE RING-SECTION PUMPS

API-610 TYPE: BB4

TERMOMECCANICA PUMP MODEL: MES - MESD



MAIN APPLICATIONS:

- Main & start-up boiler feed water for fossil fuel power plants
- High pressure auxiliary services in general industry, petrochemical and RO Desalination plants
- Fire fighting systems
- Water transmission pipelines and water distribution
- Sea water transfer in nuclear power plants
- Condensate extraction

KEY FEATURES:

- Between bearings, single casing, radially split, and multistage pumps with a diffuser design
- Suction and discharge covers are center-line mounted
- Casings are pressed together by external tie bolts and sealed by confined o-rings
- The MESD model has a first stage double suction impeller for low NPSH applications
- Top-top suction and discharge nozzles are standard
- Hydraulic axial thrust is compensated by a balancing disk or balancing drum
- A bleed off nozzle can be provided
- The bearing design depends on the type of axial thrust balancing system
- A special product lubrication bearing design is available for high pressure reverse osmosis service

OPERATING RANGE

- Capacity: up to 2,000 m³/h 8,800 gpm
- Head: up to 4000 m 13,100 ft.
- Pressure: up to 450 bar 6,530 psig
- Temperature: up to +220 °C 428 °F
- Speed of rotation up to 7,000 rpm 7,000 rpm

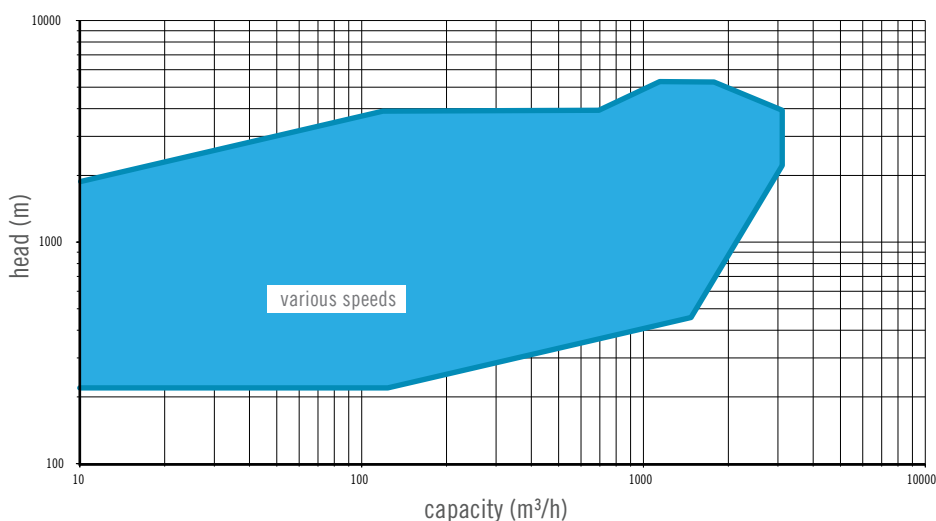

API 610 BB5-TYPE PUMPS • TMP MESB-MESBD PUMP MODELS
PHOTO: TMP MESB PUMP MODEL FOR EXPORT OIL SERVICE AT OFFSHORE OIL FIELD FACILITY

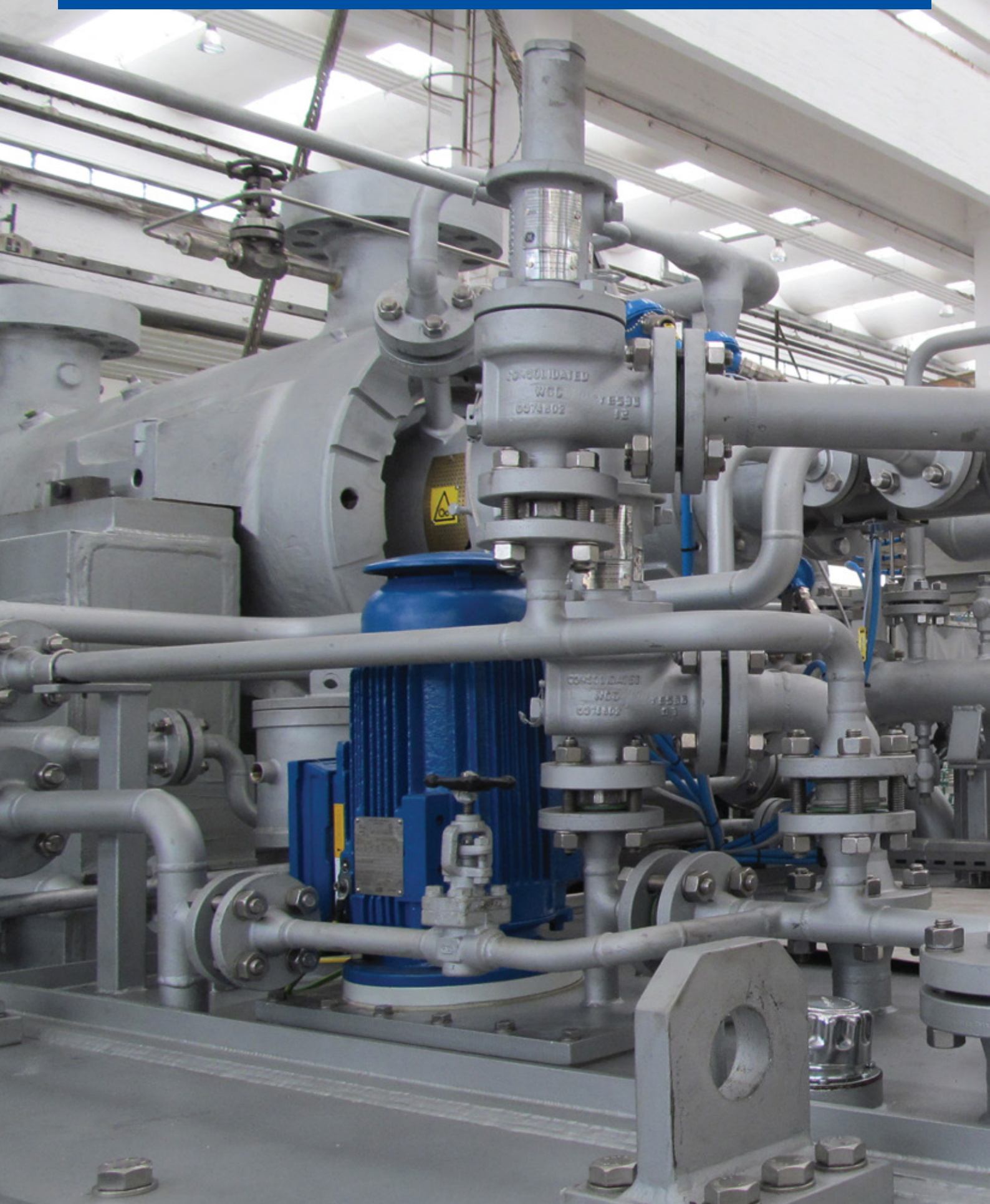

HORIZONTAL HIGH PRESSURE MULTI-STAGE BARREL PUMPS

API-610 TYPE: BB5

TERMOMECCANICA PUMP MODEL: MESB - MESBD



MAIN APPLICATIONS:

- Main & start-up boiler feed for any type of fossil fuel & nuclear power plants
- Nuclear auxiliary services
- Water and oil transportation
- Oil well water injection - onshore and offshore
- High pressure applications in refinery and petrochemical plants

KEY FEATURES:

- Between bearings, double casing, radially split, and multistage pumps with a diffuser design
- A full cartridge pull-out solution is standard for simple and efficient dismantling
- The MESBD models are first stage double entry impeller for low NPSH applications
- A bolted discharge cover design is available
- For high stage numbers, a back-to-back arrangement is adopted
- A bleed-off nozzle can also be provided
- The hydraulic axial thrust is compensated by a balancing drum
- Antifriction or hydrodynamic bearings can be supplied based on operating parameters

OPERATING RANGE

- | | | | |
|---------------------|-------|-------------------------|-------------|
| • Capacity: | up to | 3,000 m ³ /h | 13,210 gpm |
| • Head: | up to | 7,000 m | 23,000 ft. |
| • Pressure: | up to | 1,000 bar | 14,500 psig |
| • Temperature: | up to | +450 °C | 842 °F |
| • Speed of rotation | up to | 7,000 rpm | 7,000 rpm |

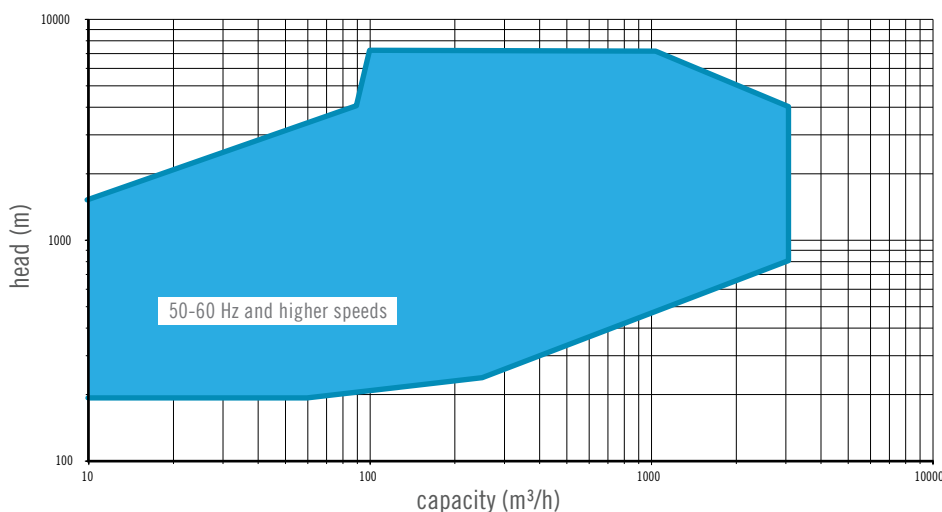

API-610 VS1-VS2 TYPE PUMPS • TMP CPP- CPPD PUMP MODELS
PHOTO: TMP CPP PUMP MODEL FOR SEA WATER SUPPLY SERVICE AT PETROCHEMICAL PLANT AND LNG TERMINAL

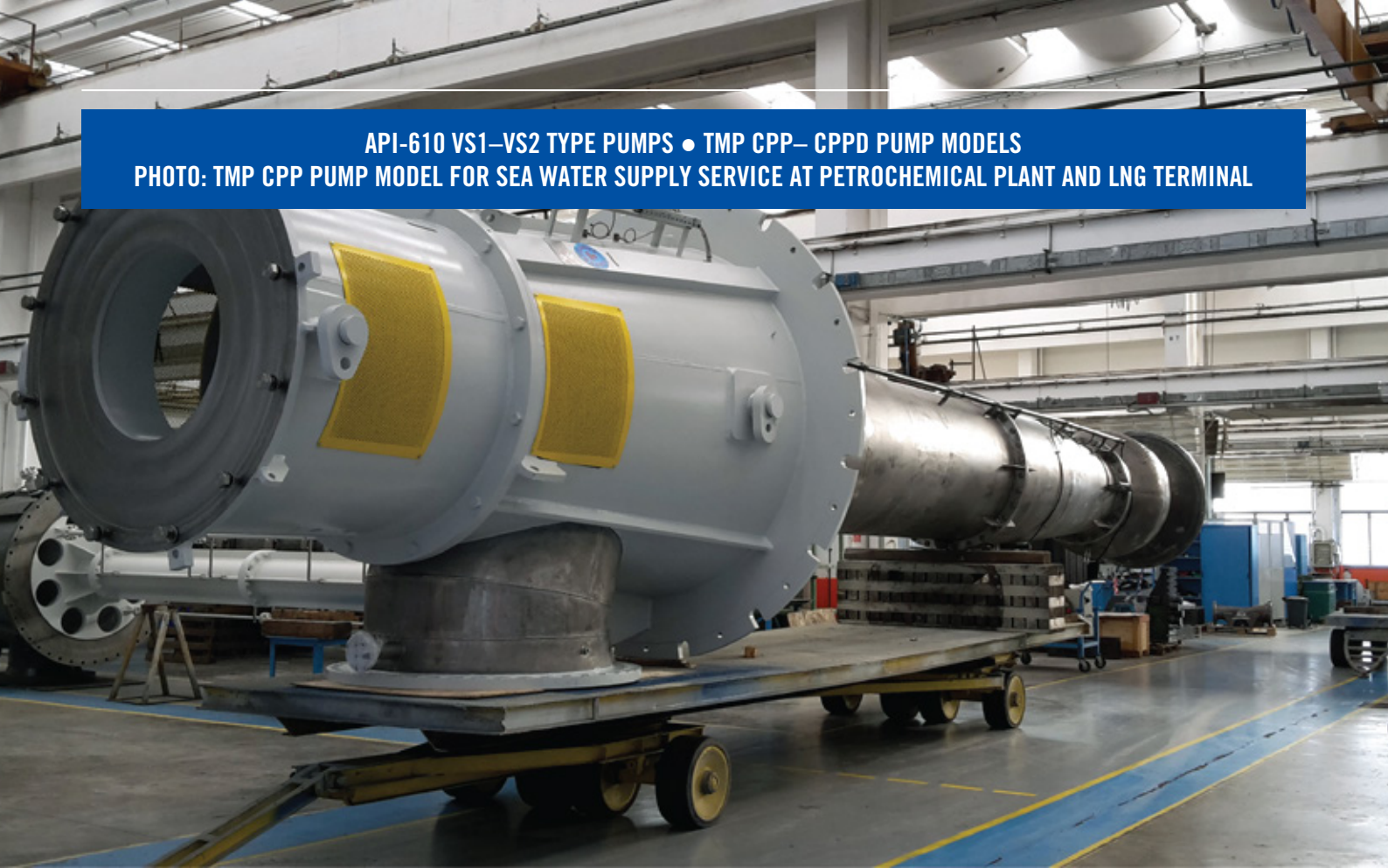

VERTICALLY SUSPENDED, WET PIT, SINGLE CASING, SINGLE OR MULTISTAGE, DIFFUSER OR VOLUTE PUMPS

API-610 TYPE: VS1 – VS2

TERMOMECCANICA PUMP MODELS: CPP - CPPD



CPP

CPPD

KEY FEATURES:

- Wet pit, vertically suspended, single casing pumps with discharge through the column
- The CPP model refers to single or multistage diffuser pumps (VS1), with radial or mixed flow impellers
- The CPPD models refer to single stage volute pumps (VS2), with a single or double suction radial impeller
- A very wide number of hydraulics is available for an optimal selection
- Designs in full compliance with API 610 are available on small and medium size standardized models
- Larger sizes are custom-made, designed in compliance with international standards, including API 610
- For large capacities, CPP pumps can also be supplied in dry pit solutions

MAIN APPLICATIONS:

- Condenser cooling water
- Industrial cooling water services
- Water supply
- Flood control and irrigation
- Desalination sea water intake
- Offshore sea water lift
- Hydrocarbon pipelines and transfer service
- Chemical and petrochemical auxiliary services
- Molten salt services in solar power plants
- Fire fighting

OPERATING RANGE

- | | | | |
|----------------|-------|---------------------------|-----------------|
| • Capacity: | up to | 100,000 m ³ /h | 440,000 gpm |
| • Head: | up to | 2,000 m | 6,560 ft. |
| • Pressure: | up to | 220 bar | 3,190 psig |
| • Temperature: | up to | -150 to +400 °C | -300 to +750 °F |
| • Settings: | up to | 50 m | 164 ft. |

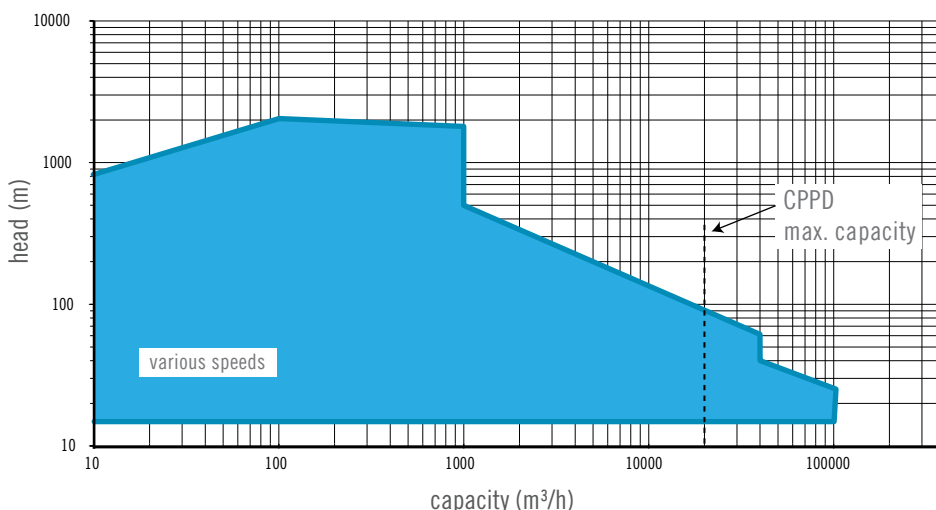

API 610 VS3-TYPE PUMP • TMP EV PUMP MODEL FOR WATER APPLICATIONS



VERTICALLY SUSPENDED, WET PIT, SINGLE-CASING, AXIAL-FLOW PUMPS

API-610 TYPE: VS3

TERMOMECCANICA PUMP MODEL: EV



KEY FEATURES:

- Vertical or inclined propeller pumps, suitable for pumping large flow rates at low pressure on wet pit applications
- Wide range of hydraulics available in combination with a variety of materials and construction options to meet any special service requirement
- Adjustable impeller vanes or inlet guide vane design also available (EVR)
- On large size pumps, pull out design is recommended for easy maintenance

MAIN APPLICATIONS:

- River intake
- Irrigation
- Land reclamation and flooding control
- Water treatment
- Cooling water
- Dry docks
- Storm and drain water services

OPERATING RANGE

- Capacity: up to 13,000 m³/h 572,400 gpm
- Head: up to 15 m 49 ft.
- Pressure: up to 2 bar 29 psig
- Temperature: up to 50 °C 120 °F

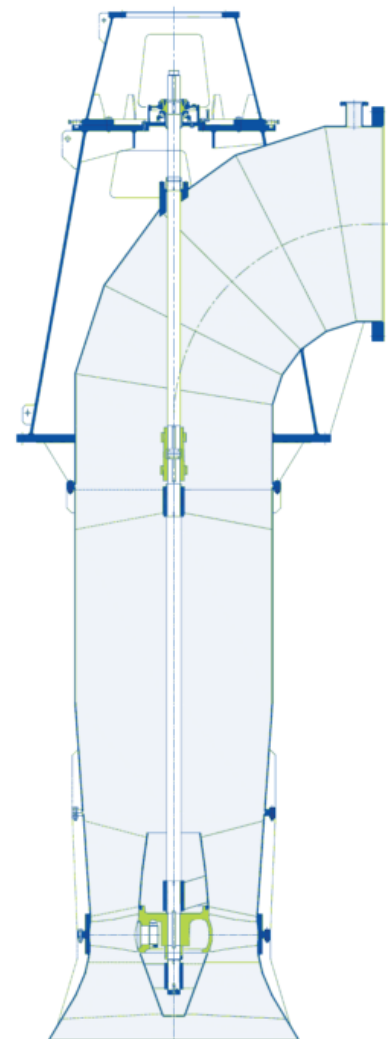
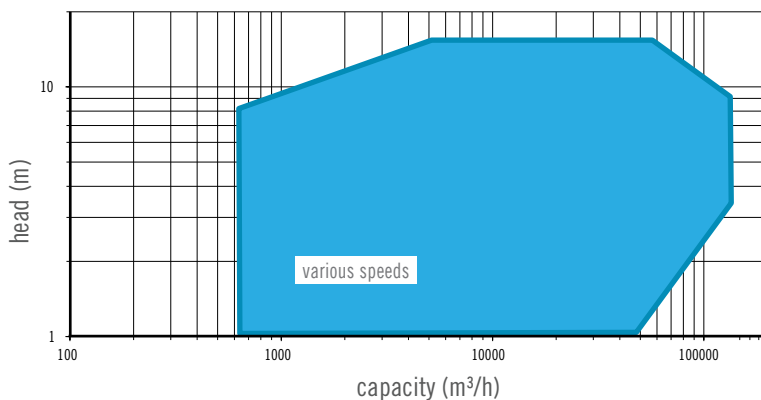

API-610 VS4-TYPE PUMPS • TMP CPPL PUMP MODEL
PHOTO: API 610 VS4-TYPE PUMP FOR CLOSED DRAIN DRUM SERVICE AT GAS FIELD

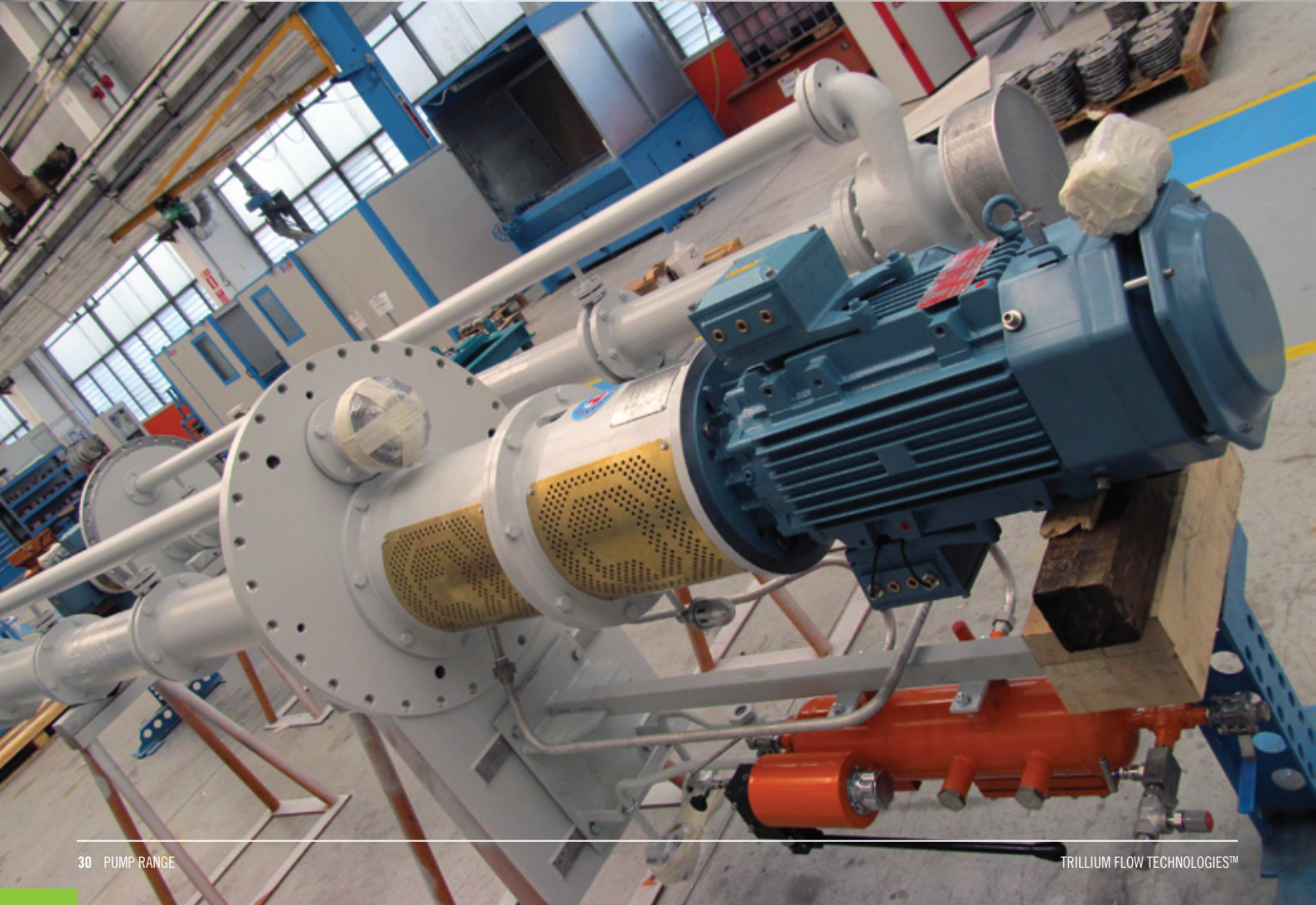

VERTICALLY SUSPENDED, SINGLE-CASING, VOLUTE, LINE-SHAFT DRIVEN SUMP PUMPS

API-610 TYPE: VS4

TERMOMECCANICA PUMP MODEL: CPPL



MAIN APPLICATIONS:

- Hydrocarbon & chemical processing
- Liquid transfer
- Recovered oil tank
- Drain water services
- General Industry
- Melted sulphur

KEY FEATURES:

- Designed for installation in wet pit depths up to 10 meters
- Volute casing with radial split design
- Impellers are enclosed type but semi-open solutions are also available for special duties (high viscosity, suspended solids)
- The motor support is bolted to the pump mounting plate; motor support and column pipe are centered on the pump mounting plate
- The lower pump shaft can be one piece or divided into sections connected by rigid couplings; intermediate radial bushings are fitted on bearing holders which are fixed between the column pipe flanges
- The discharge column is external and parallel to the column pipe and connects the discharge branch of the casing to the pump mounting plate

OPERATING RANGE

- Capacity: up to 1,000 m³/h 44,000 gpm
- Head: up to 200 m 650 ft.
- Pressure: up to 40 bar 580 psig
- Temperature: range -30 to + 260 °C -86 to +500 °F

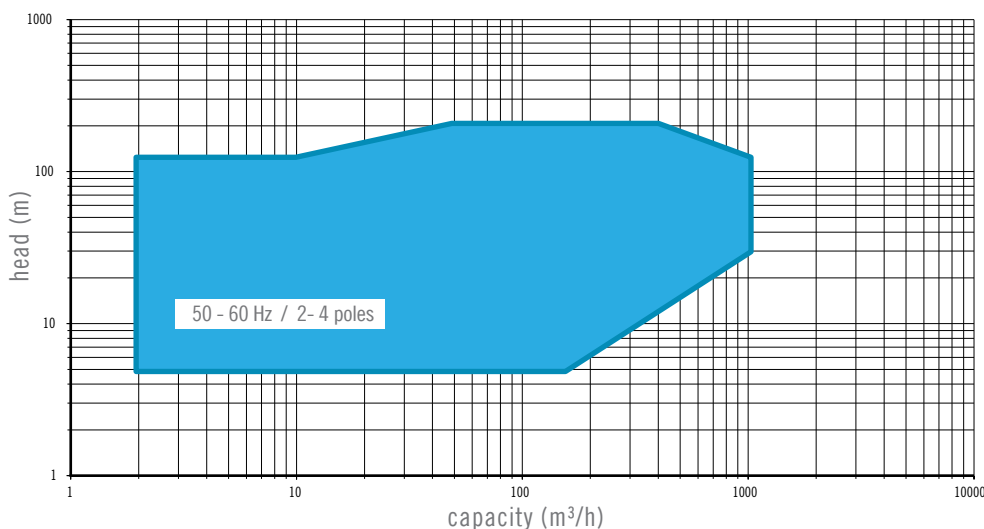



API-610 VS6-VS7 TYPE PUMPS • TMP CEX-CEXD PUMP MODELS
PHOTO: TMP CEXD PUMP MODEL FOR BRINE RECYCLE SERVICE AT DESALINATION PLANT

VERTICALLY SUSPENDED, CANNED, SINGLE- OR DOUBLE-SUCTION, SINGLE- OR MULTI-STAGE PUMPS

API-610 TYPE: VS6 – VS7

TERMOMECCANICA PUMP MODELS: CEX – CEXD



CEX



CEXD

MAIN APPLICATIONS:

- Condensate extraction in power plants
- Circulating pumps in geothermal power plants
- Main process pumps in thermal sea water desalination plants
- Hydrocarbon pipelines or oil transfer
- General refining
- LPG, LNG cryogenic services

KEY FEATURES:

- Canned pumps, radial or mixed flow impellers, single or multi-stage design
- Double entry impeller to minimize the suction can length
- Availability of wide number of hydraulics for an optimum selection
- Design in full compliance with API 610 is available on small/medium size standardized models
- Large sizes are custom-made pumps, designed in compliance with international standards, including API 610
- Discharge nozzle above the foundation floor or in the suction can is possible
- Elastic or rigid coupling between pump and motor
- In elastic coupling design, axial thrust bearing assembly located on top of discharge head. Bath oil lubrication with antifriction bearings; for high power or high thrust services, a tilting pad thrust bearing is used

OPERATING RANGE

- Capacity: up to 20,000 m³/h 88,000 gpm
- Head: up to 2,000 m 6,562 ft.
- Power: up to 220 bar 3,190 psig
- Temperature: range -150 to +400 °C -300 to +750°F

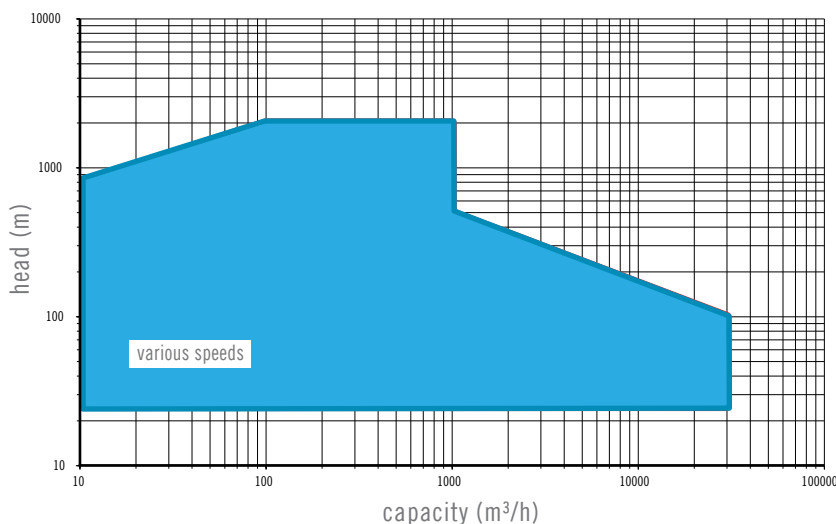

VERTICAL VOLUTE DRY PIT PUMPS • TMP NV PUMP MODEL
PHOTO: CONCRETE VOLUTE PUMP FOR LAND RECLAMATION PROJECT



VERTICAL VOLUTE DRY PIT LARGE PUMPS

API-610 TYPE: N/A

TERMOMECCANICA PUMP MODEL: NV



APPLICATIONS:

- condensate extraction in power plants
- circulating pumps in geothermal power plants
- process pumps in thermal sea water desalination plants
- carbon pipelines or oil transfer
- chemical refining
- LNG cryogenic services

KEY FEATURES:

- Vertical, dry pit, single stage, metallic or concrete volute pumps with or without guide vanes
- Radial or mixed flow impeller
- Pull-out design allows rotor & pump cover to be easily removed for maintenance
- Packing or mechanical seal
- Different solutions for axial & radial bearings are available depending on pumping unit arrangement

OPERATING RANGE

- Capacity: up to 120,000 m³/h 528,000 gpm
- Head: up to 130 m 425 ft.
- Power: up to 12,000 kW 16,300 Hp

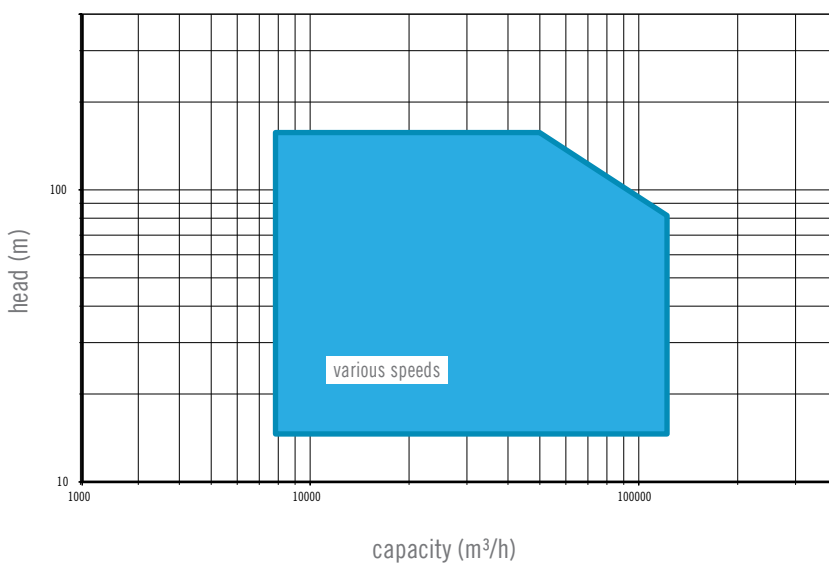

NOTES:

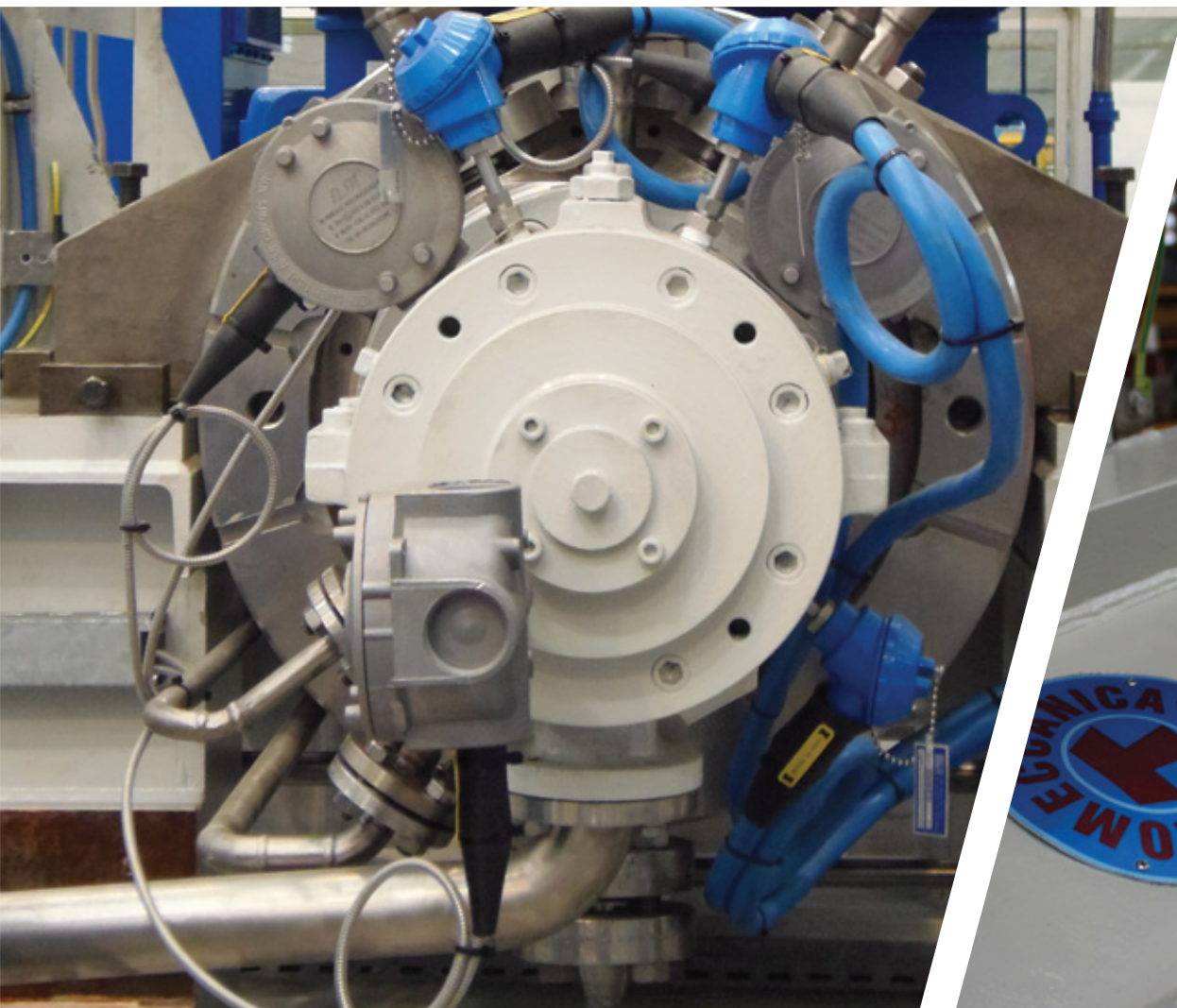

Termomeccanica Pompe S.p.A.

Via del Molo 3
19126 La Spezia - Italy

TRILLIUMFLOW.COM